



Medical



Type 55909
6V 10W G4

Ordering - No.
55909

Product Description

Special Halogen Lamp

Features

Quartz Bulb, Exactly positioned Filament

Applications

Medical, Microscope, Analysis

Technical Details

Rated Voltage (V)	6
Wattage (W)	max. 11,0
Luminous Flux (lm)	205 ± 12%
Average Lifetime (h)	100
Base	G4
Overall Length (mm)	max. 30
Bulb Diameter (mm)	max. 8,5
Light Center Length (mm)	19,5 ± 0,25
Operating Position	s90
Packaging Configuration	100 pcs.
Environmental Remark	Product don't contain lead or mercury and is conform with Directive 2011/96/EC "Restriction of the use of certain hazardous substances in electrical and electronic equipment".

Drawing (in mm)

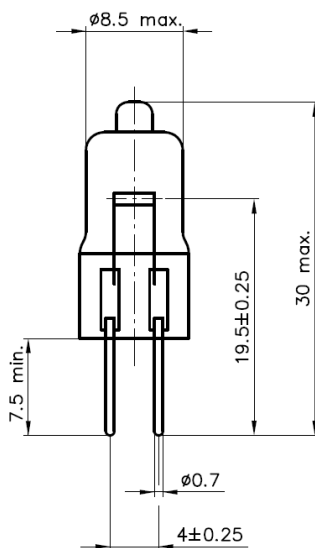

valid from	05.03.2014—V2—PN14/0072
replace for	12.12.2013—V1
file	55909.100.pdf